

EZ-BULK 48 x 40 Series
275 Gallon Recyclable Liquid Bulk Container

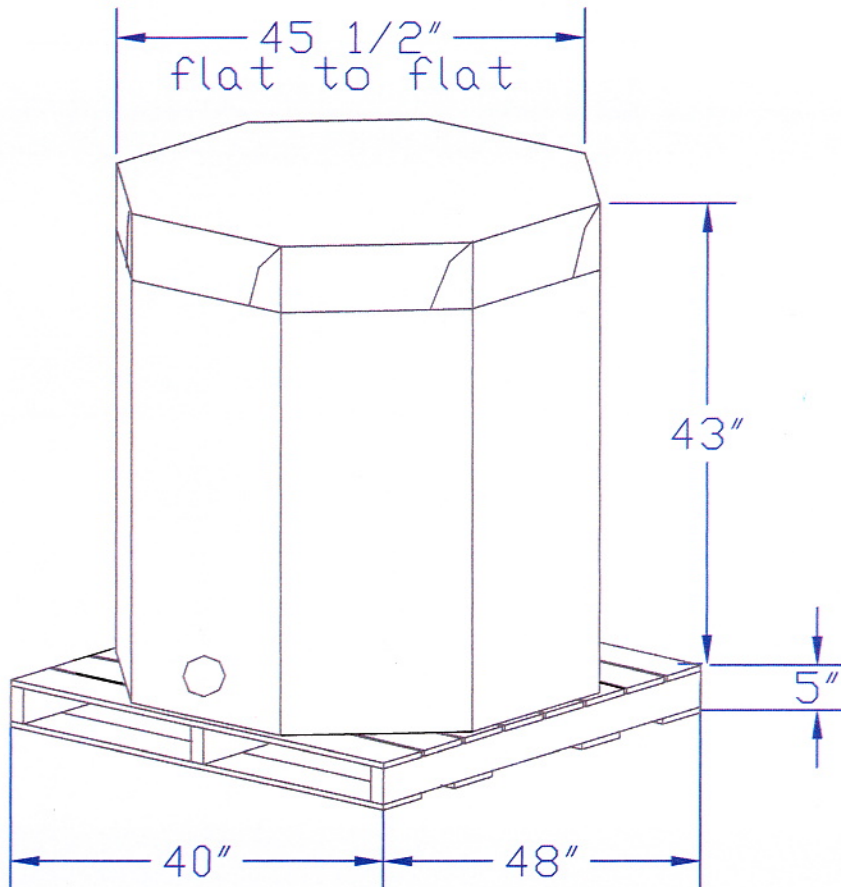

Approx. tare weight without pallet = 46 lbs



P.O. Box 6188
321 SW 4th Street
Des Moines, IA 50309, USA

www.paper-systems.com psi@paper-systems.com
Ph: 515 280-1111 Fax: (515) 280-9219